

# IC series

Pushbutton switches for harsh environments - short case - bushing  $\varnothing$  12 mm - momentary

*Distinctive features and specifications*



- Momentary with short case, reduced behind-panel depth
- Tactile feedback
- Flat round actuator for optional marking
- Glossy actuator option (round curved only)
- Sealed to IP67

## ENVIRONMENTAL SPECIFICATIONS

- Front panel sealing : IP67 according to IEC 60529
- Shock resistance : 100 g according to IEC 512-4, test 6c
- Vibration resistance : 10-500Hz - 10 g according to IEC 512-4, test 6d
- Salt spray : IEC 512-6, test 11f
- Robustness : IK06 according to EN 50102 (1 joule)
- Operating temperature : -40°C to +85°C

## GENERAL SPECIFICATIONS

- Panel thickness : 1,5 mm (.059) min. 4 mm (.157 max.)
- Total travel : 1,7 mm (.067)+/- 0,3 mm
- Typical operating force : 4N +/- 2N
- Mechanical life : 1.000.000 cycles
- Torque : 1,5 Nm max. applied to nut
- Soldering : 320°C max. for 3 sec.

## ELECTRICAL SPECIFICATIONS

- Max. current/voltage rating with resistive load :  
0,2A 48VDC, 500.000 cycles  
0,5A 48VAC, 500.000 cycles
- Initial contact resistance : 50 m $\Omega$  max.
- Insulation resistance : 1 G $\Omega$  min. at 500VDC
- Dielectric strength : 1.500 Vrms 50 HZ between terminals

## MATERIALS

- Case : thermoplastic UL94-V0
- Actuator : polyamide 6/6
- Bushing/bezel : zinc die-cast (zamac), black painted
- Contacts : brass, gold plated
- Multi-wire lead AWG20, section 0,6 mm<sup>2</sup>
- Terminal seal : epoxy

## MOUNTING

### Panel cut-out

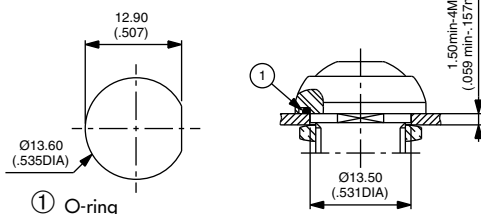

### Matrix mounting

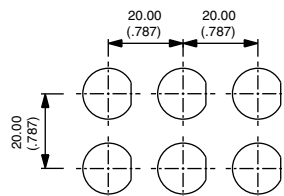

### Back of panel space requirement

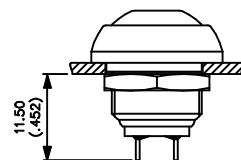

# IC series

Pushbutton switches for harsh environments - short case - bushing Ø 12 mm - momentary

Overview

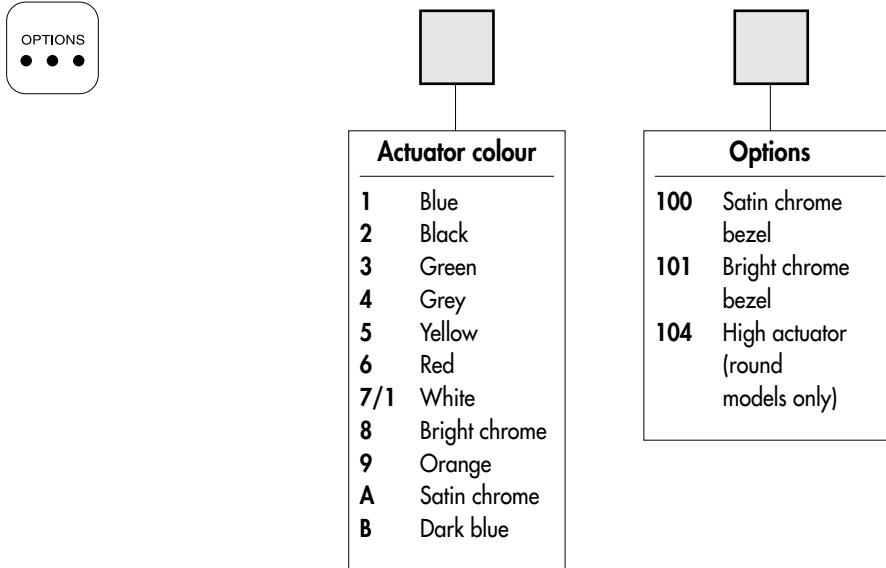
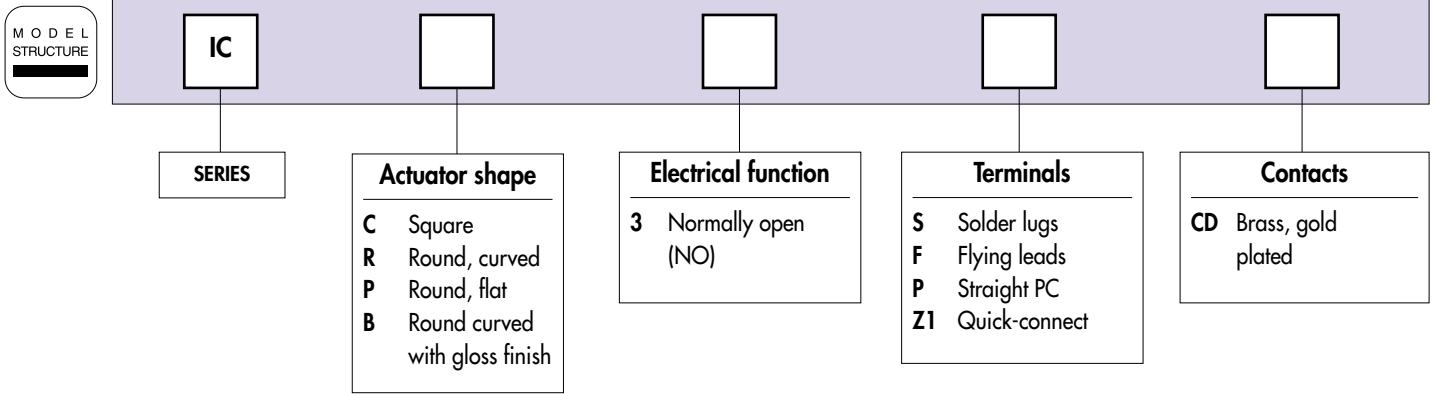

## ABOUT THIS SERIES

On the following pages, you will find successively :  
model structure of switches and options in the same order as in above chart

**Dimensions** : first dimensions are in mm while inches are shown as bracketed numbers.



**NOTICE** : please note that not all combinations of above numbers are available. Refer to the following pages for further information.



**A sealing boot** is available to protect the switches against frost and sand. It is presented at the end of this catalogue.



**Mounting accessories** : Standard hardware supplied : 1 hex nut 14 mm (.551) across flats and 1 O-ring. Hex nut part number U166.



**Packaging unit** : 25 pieces

# IC series

Pushbutton switches for harsh environments - short case - bushing  $\varnothing$  12 mm - momentary

Square

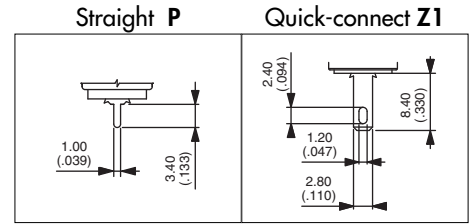
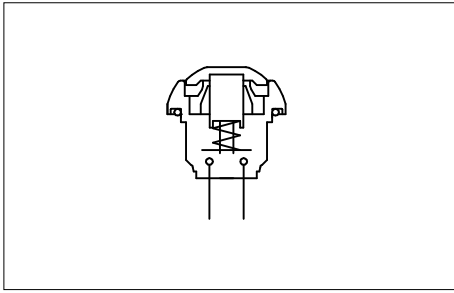

MODEL  
STRUCTURE

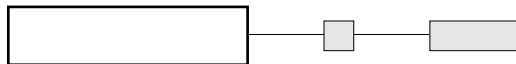

## Solder lug terminals

→ Flat



ICC3SCD



Normally Open

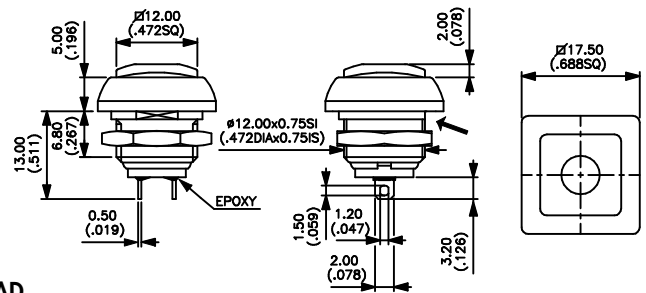

Also available with straight PC terminals : **ICC3PAD**  
and quick-connect terminals : **ICC3Z1AD**

## Sealed flying lead terminals

→ Flat



ICC3FCD



Normally Open

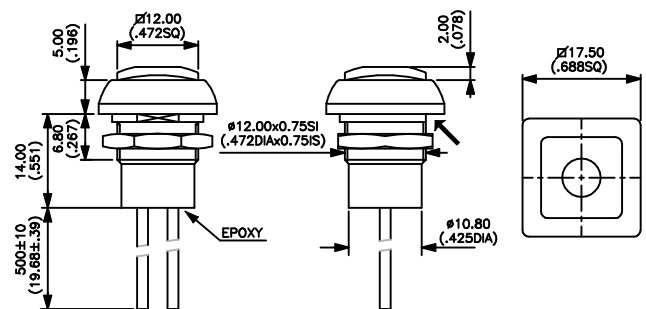

Wire colours (NC/NO) : black : NO, blue : NC

## ACTUATOR COLOUR

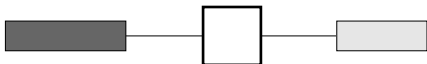

1 : blue - 2 : black - 3 : green - 4 : grey - 5 : yellow - 6 : red - 7/1 : white - 8 : bright chrome - 9 : orange  
A : satin chrome - B : dark blue

## OPTIONS

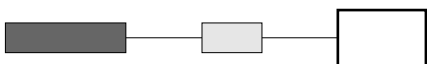

100 : Satin chrome bezel  
101 : Bright chrome bezel

# IC series

Pushbutton switches for harsh environments - short case - bushing  $\varnothing$  12 mm - momentary

Round

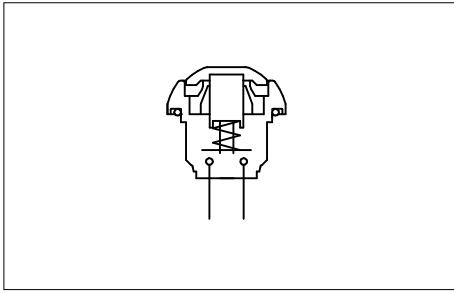

**• Gloss actuator finish**

Curved actuator also available with gloss finish - replace ICR by ICB in the part numbers below.

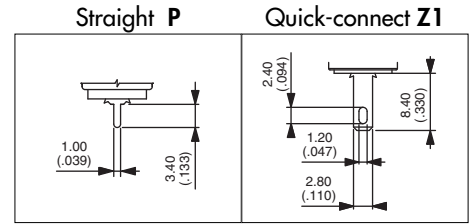

**MODEL STRUCTURE**

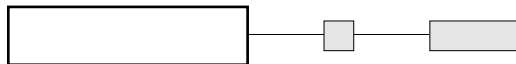

Actuator marking available on ICP models (symbol 10 mm max.). On request.

**Solder lug terminals**

→ Flat



Curved actuator  
**ICR3SCD**



Flat actuator  
**ICP3SCD**

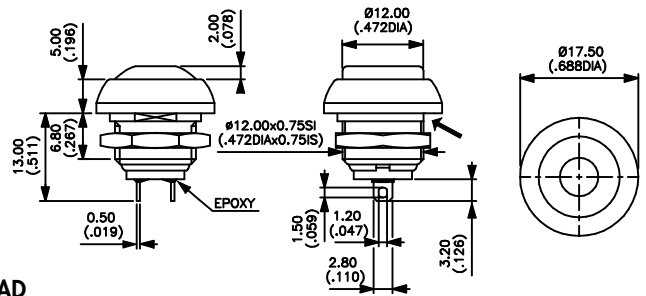

Also available with straight PC terminals : **IC•3PAD**  
and quick-connect terminals : **IC•3Z1AD**

**Sealed flying lead terminals**

→ Flat



Curved actuator  
**ICR3FCD**



Flat actuator  
**ICP3FCD**

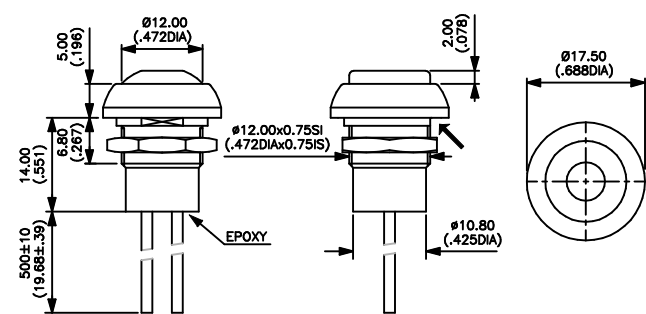

Wire colours (NC/NO) : black : NO, blue : NC

**ACTUATOR COLOUR**

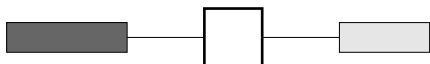

1 : blue - 2 : black - 3 : green - 4 : grey - 5 : yellow  
6 : red - 7/1 : white - 8 : bright chrome - 9 : orange  
A : satin chrome - B : dark blue -

**OPTIONS**

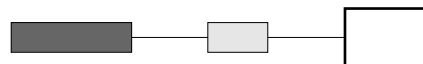

100 : Satin chrome bezel  
101 : Bright chrome bezel  
104 : High actuator

